

Republic offers a complete line of regenerative blowers for high vacuum or compressed air applications in both horizontal and vertical mounted positions. TEFC motors are rated for 50/60 Hz operation and are IE3, cUL, UL, and CE certified. The impeller is directly connected to the motor shaft, providing powerful air force without undue friction. The bearings are outside the compression chamber, ensuring maximum operational reliability under high differential pressure. Constructed in robust die-cast aluminum, this low-maintenance, oil-free design provides continuous, dependable service to our customers.

IE3
CC339B
CE
C **UL** **US**
E493872

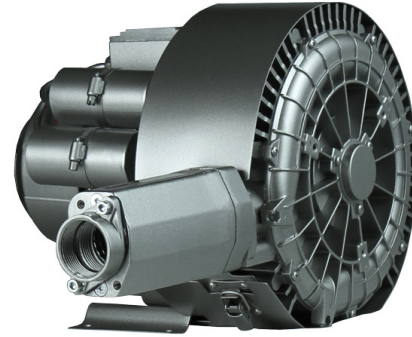

PERFORMANCE

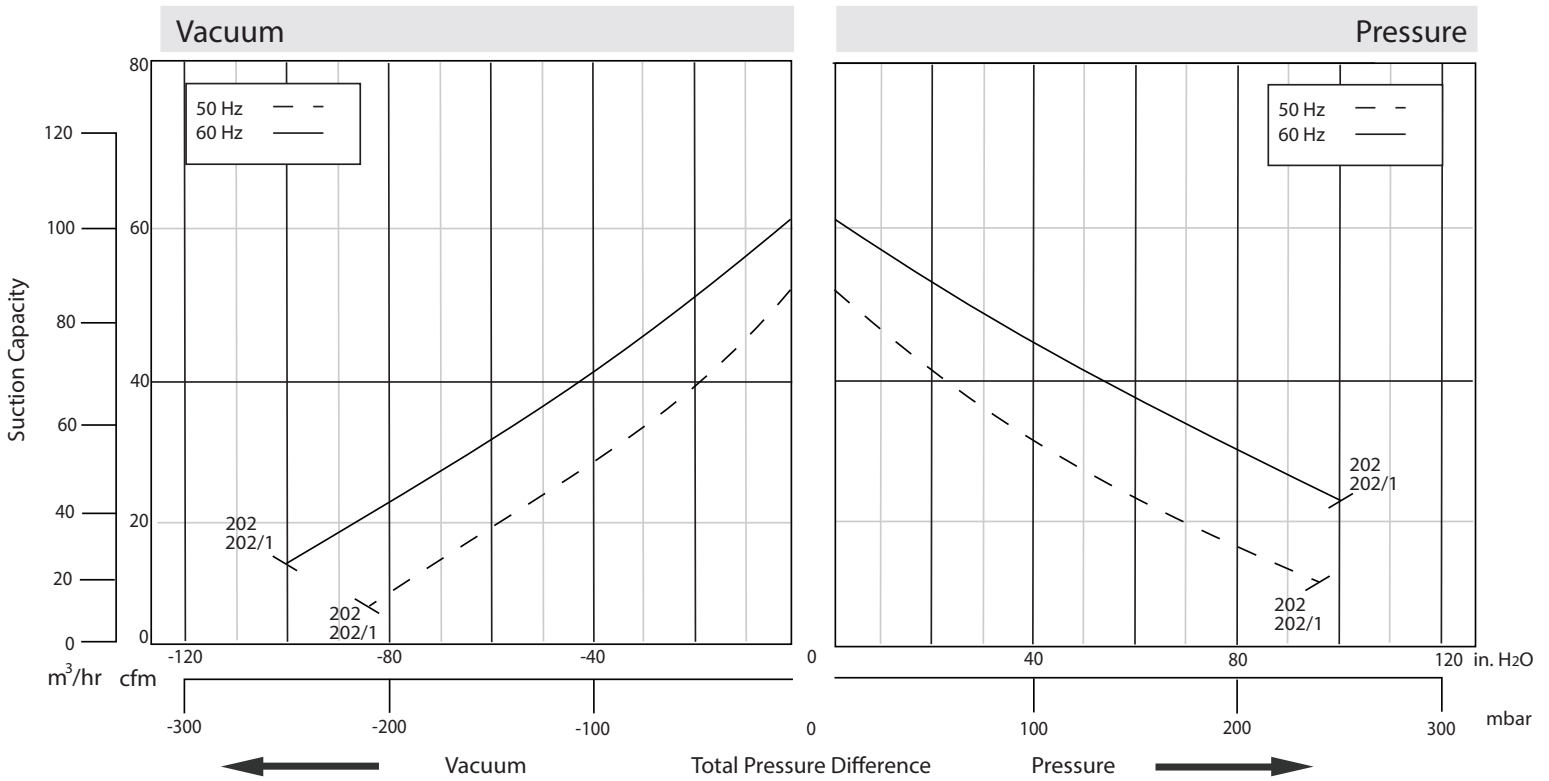

Model	Phase	Frequency (Hz)	Air flow (CFM/m³/hr)	Rated Vacuum (in. H ₂ O/mbar)	Rated Pressure (in. H ₂ O/mbar)	Motor (HP/kW)	Voltage (V)	Current (A)	Sound Level (dB)	Weight (lb/kg)
HRC 202	3	50	49/83	84/210	96/240	0.9/0.7	190 YY/380 Y	3.2 YY/1.6 Y	55	33/15
		60	61/103	100/250	100/250	1.1/0.9	230 YY/460 Y	3.3 YY/1.7 Y	61	
HRC 202/1	1	50	49/83	84/210	96/240	0.9/0.7	230	4.5	55	35/16
		60	61/103	100/250	100/250	1.1/0.9	115/230	11.2/5.6	61	

The performance curves are based on air at a temperature of 59 °F and an atmospheric pressure of 29.91 inch Hg with a tolerance of +/-10%. The total pressure differences are valid for inlet and ambient temperatures up to 77 °F. Suction capacity relates to inlet conditions. Pressure capacity relates to atmospheric conditions. For other conditions please contact Republic. Three phase motor tolerances are +/-10% for fixed voltage motors and +/-5% for voltage range motors. Single phase machines are designed with a +/-5% tolerance. The frequency tolerance is +/-2% maximum.

APPROXIMATE DIMENSIONS

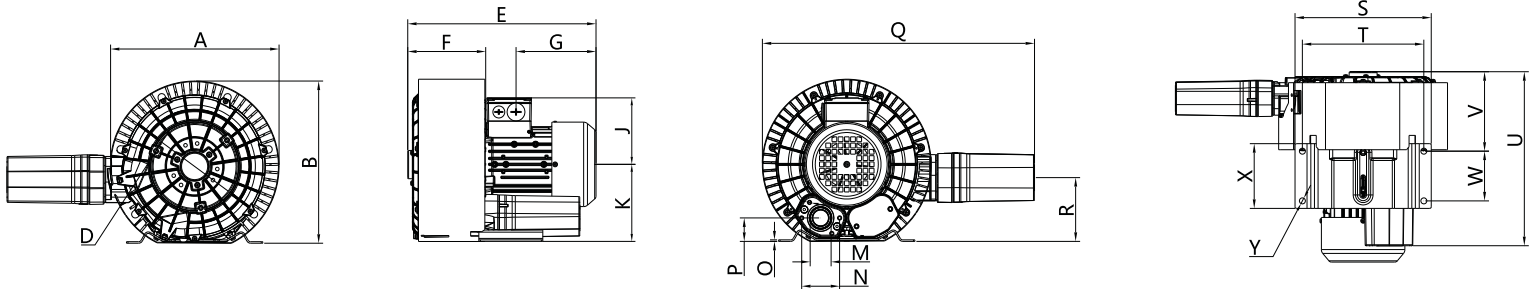

Model	Unit	A	B	D	E	F	G	J	K	M	N	O	P	Q	R	S	T	U	V	W	X	Y
HRC 202	in	11.18	10.63	M6	12.52	5.20	5.31	4.37	5.04	1.25	2.52	0.10	1.54	18.07	4.17	9.06	8.07	11.42	4.72	3.27	4.25	0.39
	mm	284	270		318	132	135	111	128		64	2.5	39	459	106	230	205	290	120	83	108	10
HRC 202/1	in	11.18	10.63	M6	12.52	5.20	5.31	4.37	5.04	1.25	2.52	0.10	1.54	18.07	4.17	9.06	8.07	11.42	4.72	3.27	4.25	0.39
	mm	284	270		318	132	135	111	128		64	2.5	39	459	106	230	205	290	120	83	108	10

Available Options

All Republic Regenerative Blowers are available in pre-assembled kits for either pressure or vacuum applications. These kits include an inlet filter, gauge and relief valve, and are factory tested prior to shipment. Optional items for these kits include check valve, and tube adaptor; washdown motors, explosion proof motors, or other specialty motors; noise enclosures; and control panels such as VFD's, PLC's, or starter panels.

VACUUM KIT

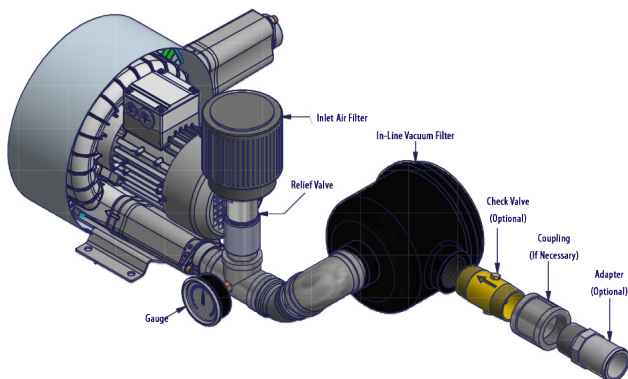

PRESSURE KIT

